

RBD2 - RBD3

DISTRIBUTORI 2"G - 3"G DISTRIBUTORS 2"G - 3"G

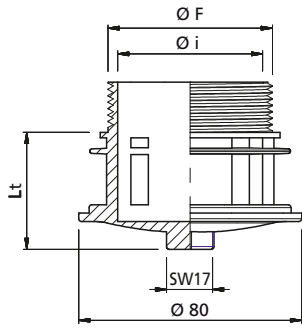

- Sistemi di distribuzione superiore per filtri a sabbia e carbone
- Upper distribution systems for sand and activated carbon filters



RBD2

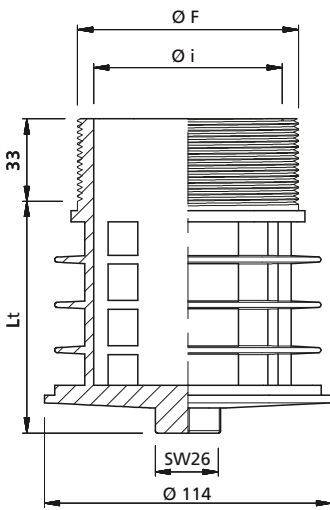
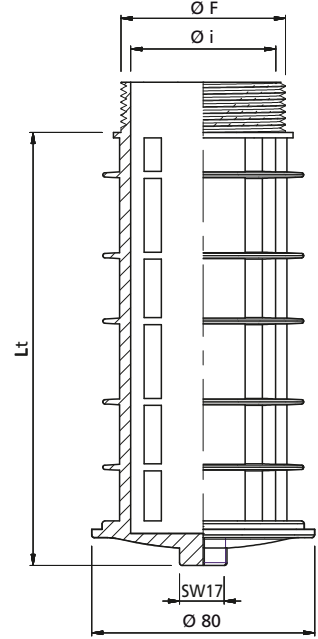
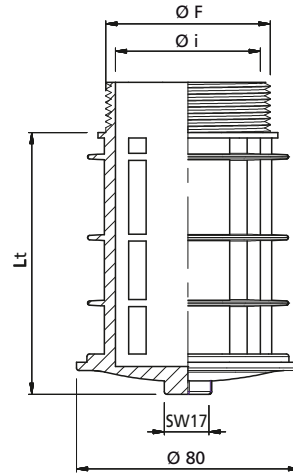

RBD3

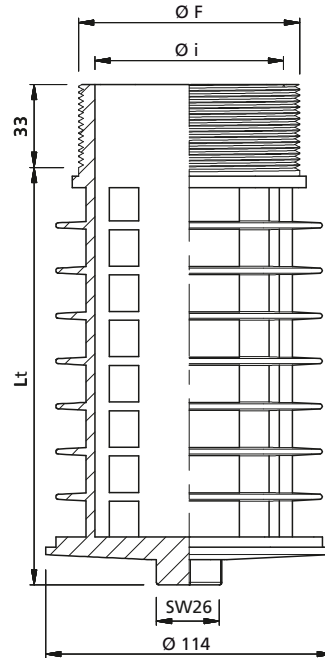

Tipo Type	ØF Filetto Thread	Øi mm	Lt mm
RBD2	2"G	52	73
		52	110
		52	170
RBD3	3"G	75	96
		75	168
		75	240

Materiale/Material: PP

Come ordinare How to order	Distributore Distributor	Lt	Materiale Material
Esempio / Example	RBD 3	168	PP

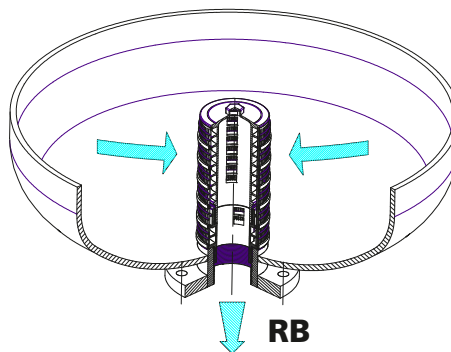

RB

Drenaggio di fondo
Bottom drain

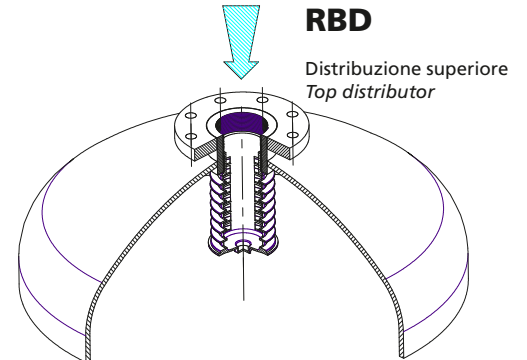

RBD

Distribuzione superiore
Top distributor